

kapitola 12 - armatury pro rozvody plynu

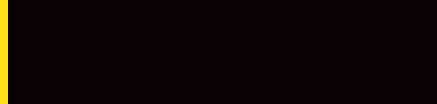

2013



Art. TM 2200G
 plnopřítokový kulový kohout
 URAGANO
 pro plyn, provedení MMP
 ISO 7

objednávací kód	provedení	cena v Kč	balení
TM2200G0702	1/4"	127,-	25 / 100
TM2200G0703	3/8"	127,-	25 / 100
TM2200G0704	1/2"	140,-	20 / 80
TM2200G0705	3/4"	189,-	10 / 40
TM2200G0706	1"	288,-	8 / 32
TM2200G0707	1"1/4	499,-	4 / 16
TM2200G0708	1"1/2	734,-	3 / 12
TM2200G0709	2"	1.074,-	2 / 8
TM2200G0710	2"1/2	3.148,-	1 / 4
TM2200G0711	3"	4.616,-	1 / 3
TM2200G0712	4"	8.075,-	1 / 1



Art. TM 2201G
 plnopřítokový kulový kohout
 URAGANO
 pro plyn, provedení ŠMP
 ISO 7

objednávací kód	provedení	cena v Kč	balení
TM2201G0704	1/2"	144,-	20 / 80
TM2201G0705	3/4"	195,-	10 / 40
TM2201G0706	1"	295,-	8 / 32
TM2201G0707	1"1/4	512,-	4 / 16
TM2201G0708	1"1/2	754,-	3 / 12
TM2201G0709	2"	1.101,-	2 / 8

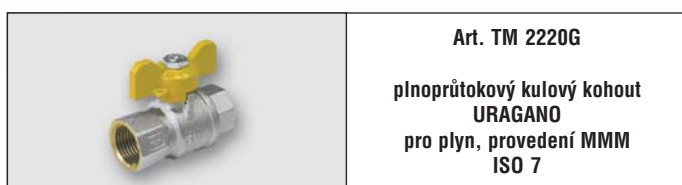

Art. TM 2220G
 plnopřítokový kulový kohout
 URAGANO
 pro plyn, provedení MMM
 ISO 7

objednávací kód	provedení	cena v Kč	balení
TM2220G0702	1/4"	101,-	25 / 100
TM2220G0703	3/8"	101,-	25 / 100
TM2220G0704	1/2"	140,-	25 / 100
TM2220G0705	3/4"	189,-	15 / 60
TM2220G0706	1"	288,-	8 / 32



Art. TM 2221G
 plnopřítokový kulový kohout
 URAGANO
 pro plyn, provedení ŠMM
 ISO 7

objednávací kód	provedení	cena v Kč	balení
TM2221G0704	1/2"	144,-	25 / 100
TM2221G0705	3/4"	195,-	15 / 60
TM2221G0706	1"	295,-	8 / 32

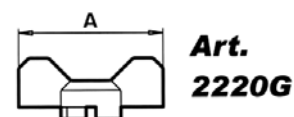
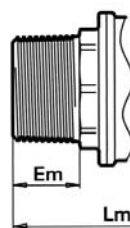
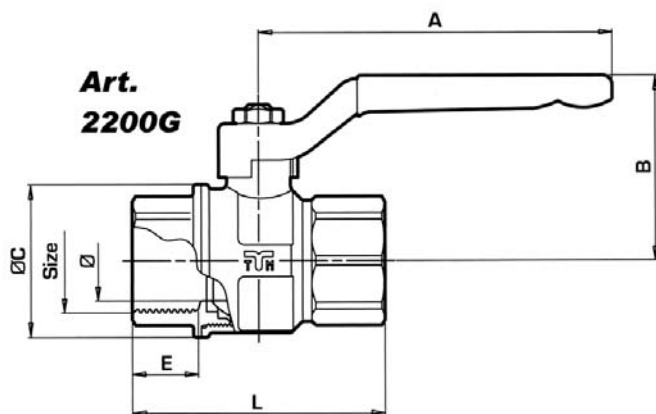

Velikost [mm]	1/4"	3/8"	1/2"	3/4"	1"	1"1/4	1"1/2	2"	2"1/2	3"	4"
ø [DN]	10,0	10,0	15,0	20,0	25,0	32,0	40,0	50,0	65,0	80,0	100,0
A 2200G	87,0	87,0	87,0	112,0	112,0	142,0	142,0	172,0	240,0	240,0	240,0
A 2220G	50,0	50,0	50,0	65,0	65,0	-	-	-	-	-	-
B	39,0	39,0	44,5	53,5	57,5	73,5	79,5	92,0	125,5	136,0	150,5
ø C	23,0	23,0	32,5	39,0	48,0	59,0	71,0	86,0	114,0	131,0	164,0
E	10,0	12,0	16,5	18,0	20,6	23,5	23,5	28,0	34,0	37,0	43,0
Em	-	11,5	18,0	18,0	21,0	23,5	23,5	28,0	-	-	-
L	42,0	47,0	67,5	67,5	79,0	96,0	105,0	126,0	156,0	177,0	211,0
Lm / f	-	57,0	75,5	75,5	87,0	106,0	114,0	136,5	-	-	-
PN	30	30	30	30	30	25	25	25	20	20	20



Art. TM 2380G07
kulový kohout TORNADO
pro plyn, provedení MMP
ISO 7

objednávací kód	provedení	cena v Kč	balení
TM2380G0704	1/2"	110,-	20 / 80
TM2380G0705	3/4"	164,-	10 / 40
TM2380G0706	1"	267,-	8 / 32
TM2380G0707	1 1/4"	407,-	4 / 16
TM2380G0708	1 1/2"	595,-	3 / 12
TM2380G0709	2"	978,-	2 / 8



Art. TM 2381G07
kulový kohout TORNADO
pro plyn, provedení ŠMP
ISO 7

objednávací kód	provedení	cena v Kč	balení
TM2381G0704	1/2"	129,-	20 / 80
TM2381G0705	3/4"	185,-	10 / 40
TM2381G0706	1"	303,-	8 / 32
TM2381G0707	1 1/4"	453,-	4 / 16
TM2381G0708	1 1/2"	656,-	3 / 12
TM2381G0709	2"	1.079,-	2 / 8



Art. TM 2370G07
kulový kohout TORNADO
pro plyn, provedení MMM
ISO 7

objednávací kód	provedení	cena v Kč	balení
TM2370G0704	1/2"	107,-	25 / 100
TM2370G0705	3/4"	157,-	15 / 60
TM2370G0706	1"	256,-	8 / 32
TM2370G0707	1 1/4"	393,-	5 / 20



Art. TM 2371G07
kulový kohout TORNADO
pro plyn, provedení ŠMM
ISO 7

objednávací kód	provedení	cena v Kč	balení
TM2371G0704	1/2"	126,-	25 / 100
TM2371G0705	3/4"	176,-	15 / 60
TM2371G0706	1"	292,-	8 / 32
TM2371G0707	1 1/4"	441,-	5 / 20

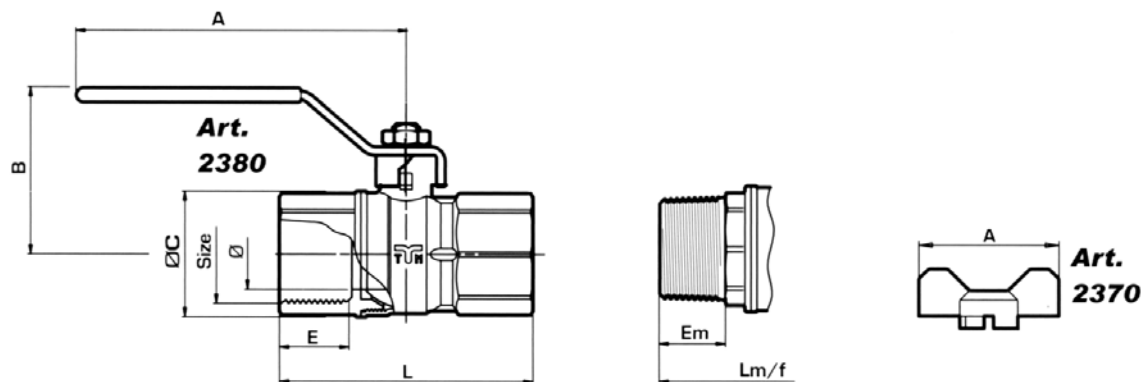

Velikost [mm]	1/2"	3/4"	1"	1 1/4"	1 1/2"	2"
ø [DN]	14,0	18,0	23,5	30,0	37,5	47,0
A 2370 / 2371	50,0	50,0	65,0	65,0	-	-
A 2380 / 2381	85,0	85,0	113,0	113,0	141,0	141,0
B	48,0	52,5	59,5	64,5	76,0	89,0
ø C	27,5	33,5	42,0	53,0	64,0	79,0
E	15,0	16,0	18,5	21,0	21,0	25,5
Em	14,7	16,2	18,7	21,2	21,2	25,7
L	58,0	66,5	78,0	93,0	101,0	121,0
Lm / f	63,5	72,0	83,0	99,1	108,0	129,0
PN	30	30	30	25	25	25

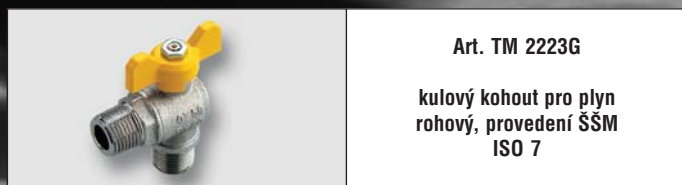

Art. TM 2223G

kulový kohout pro plyn
rohový, provedení ŠSM
ISO 7

objednávací kód	provedení	cena v Kč	balení
TM2223G0704	1/2"	166,-	20 / 80
TM2223G0705	3/4"	240,-	10 / 40

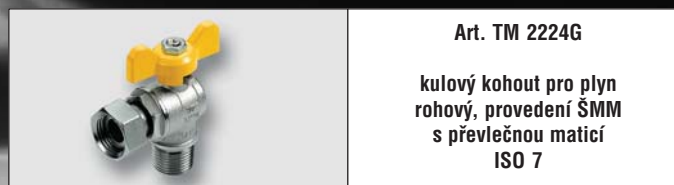

Art. TM 2224G

kulový kohout pro plyn
rohový, provedení ŠMM
s převlečnou maticí
ISO 7

objednávací kód	provedení	cena v Kč	balení
TM2224G0704	1/2"M x 1/2"Š	202,-	20 / 80
TM2224G0705	3/4"M x 1/2"Š	267,-	20 / 80
TM2224G070505	3/4"M x 3/4"Š	346,-	10 / 40



Art. TM 2260G

kulový kohout pro plyn
provedení MMP
s převlečnou maticí
ISO 7

objednávací kód	provedení	cena v Kč	balení
TM2260G0404	1/2"	268,-	20 / 80

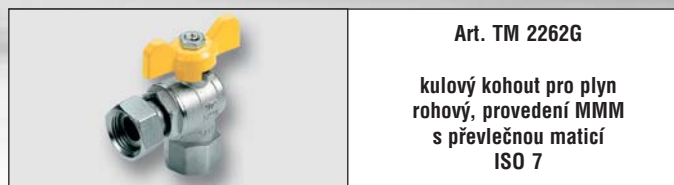

Art. TM 2262G

kulový kohout pro plyn
rohový, provedení MMM
s převlečnou maticí
ISO 7

objednávací kód	provedení	cena v Kč	balení
TM2262G0404	1/2"	268,-	20 / 80

NOVINKA



Art. TM 2261G

kulový kohout pro plyn
provedení ŠMP
s převlečnou maticí
ISO 7

objednávací kód	provedení	cena v Kč	balení
TM2261G0404	1/2"	268,-	20 / 80



Art. 91

vzorkovací kulový kohout
pro plyn

objednávací kód	provedení	cena v Kč	balení
91.010.09	3/8" x 9	194,-	1
91.010.14	3/8" x 14	194,-	1
91.015.09	1/2" x 9	194,-	1
91.015.14	1/2" x 14	194,-	1

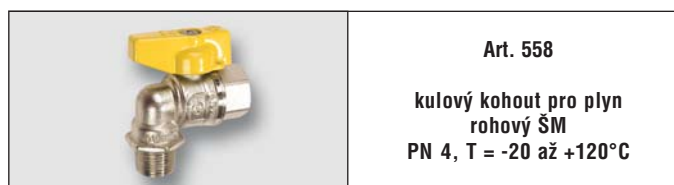

Art. 558

kulový kohout pro plyn
rohový ŠM
PN 4, T = -20 až +120°C

objednávací kód	provedení	cena v Kč	balení
558	1/2" x 1/2"	203,-	1 / 100

**SNÍŽENÍ
CENY**



Art. MBM.682xx

Plynová přípojovací hadice z ocelového vlnovce k domácím spotřebičům podle normy UNI-EN 14800 (CE 0051) s vnitřním ocelovým opletem a žlutým ochranným obalem. Splňuje nové normy na požární odolnost.

objednávací kód	provedení	DN	délka [mm]	cena v Kč	balení
MBM.68220	G 1/2" x G 1/2"	-	500	436,-	1 / -
MBM.68221	G 1/2" x G 1/2"	-	750	461,-	1 / -
MBM.68222	G 1/2" x G 1/2"	-	1000	496,-	1 / -
MBM.68223	G 1/2" x G 1/2"	-	1250	537,-	1 / -
MBM.68224	G 1/2" x G 1/2"	-	1500	570,-	1 / -
MBM.68225	G 1/2" x G 1/2"	-	2000	642,-	1 / -
MBM.68230	R 1/2" x G 1/2"	-	500	458,-	1 / -
MBM.68231	R 1/2" x G 1/2"	-	750	485,-	1 / -
MBM.68232	R 1/2" x G 1/2"	-	1000	528,-	1 / -
MBM.68233	R 1/2" x G 1/2"	-	1250	563,-	1 / -
MBM.68234	R 1/2" x G 1/2"	-	1500	602,-	1 / -
MBM.68235	R 1/2" x G 1/2"	-	2000	674,-	1 / -



Art. MBM.70xxx

Nerezová flexibilní hadice z ocelového vlnovce pro univerzální dopojení spotřebičů - voda, plyn, topení
*k dispozici od září 2010

objednávací kód	provedení	DN	délka min / max [mm]	cena v Kč	balení
MBM.70120	1/2"	15	75 / 130	166,-	1 / 18
MBM.70121	1/2"	15	100 / 200	173,-	1 / 18
MBM.70122	1/2"	15	200 / 400	196,-	1 / 18
MBM.70123	1/2"	15	260 / 480	206,-	1 / 18
MBM.70200	3/4"	20	75 / 130	255,-	1 / 18
MBM.70201	3/4"	20	100 / 200	266,-	1 / 18
MBM.70202	3/4"	20	200 / 400	307,-	1 / 18
MBM.70203	3/4"	20	260 / 520	318,-	1 / 18
MBM.70204	1/2" x 3/4"	20	75 / 130	255,-	1 / 18
MBM.70205	1/2" x 3/4"	20	100 / 200	266,-	1 / 18
MBM.70206	1/2" x 3/4"	20	200 / 400	307,-	1 / 18
MBM.70207	1/2" x 3/4"	20	260 / 520	318,-	1 / 18
MBM.70250	1"	25	75 / 130	311,-	1 / 18
MBM.70251	1"	25	100 / 200	328,-	1 / 18
MBM.70252	1"	25	200 / 400	426,-	1 / 18
MBM.70253	1"	25	260 / 520	483,-	1 / 18



Art. 472P

těsnící teflonová páska
19 mm x 15 m x 0,2 mm
pro plyn

objednávací kód	provedení	cena v Kč	balení
472P	19 mm x 15 m x 0,2 mm	viz kap.1 str.29	40 / 400

Art. MBM.65126
pryžové těsnění na plyn pro hadice MBM

objednávací kód	provedení	cena v Kč	balení
MBM.65126	1/2"	14,-	1 / 100

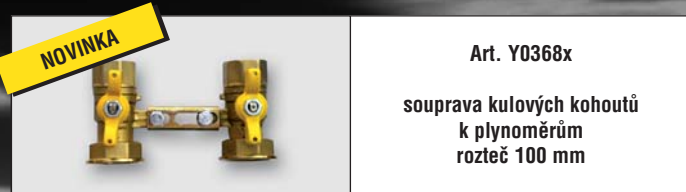

objednáací kód	provedení	cena v Kč	balení
Y03680	3/4" x 1"1/4	1.290,-	1 / 25
Y03682	1" x 1"1/4	1.390,-	1 / 25

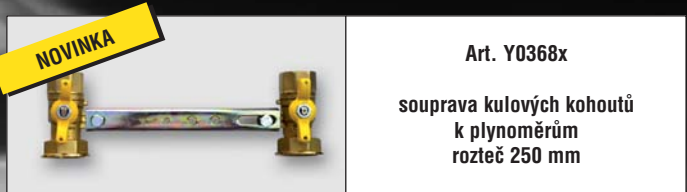

objednáací kód	provedení	cena v Kč	balení
Y03681	3/4" x 1"1/4	1.300,-	1 / 25
Y03683	1" x 1"1/4	1.400,-	1 / 25



objednáací kód	provedení	cena v Kč	balení
KHS.EKB10	12 m ³ / h	2.880,-	1

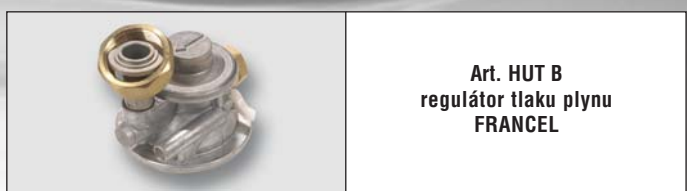

objednáací kód	provedení	cena v Kč	balení
HUT.B.6	6 m ³ / h	3.190,-	1
HUT.B.10	10 m ³ / h	4.790,-	1
HUT.B.25	25 m ³ / h	7.100,-	1



objednáací kód	provedení	cena v Kč	balení
451	1" 1/4 x 1"	120,-	10 / 100



objednáací kód	provedení	cena v Kč	balení
HUT.3659	1/2"	139,-	1 / -



objednáací kód	provedení	cena v Kč	balení
AZC.TR.304.08	3/8" DN 8	172,-	5 m
AZC.TR.304.12	1/2" DN 12	198,-	5 m
AZC.TR.304.16	3/4" DN 16	238,-	5 m
AZC.TR.304.20	1" DN 20	291,-	5 m
AZC.TR.304.25	1"1/4 DN 25	370,-	5 m



objednáací kód	provedení	cena v Kč	balení
AZC.OH.ŽL.12	DN 12	20,-	-
AZC.OH.ŽL.16	DN 16	27,-	-
AZC.OH.ŽL.20	DN 20	29,-	-
AZC.OH.ŽL.25	DN 25	35,-	-



objednáací kód	provedení	cena v Kč	balení
AZC.MT.08	G 3/8" DN 8	16,-	10
AZC.MT.12	G 1/2" DN 12	26,-	20
AZC.MT.16	G 3/4" DN 16	37,-	20
AZC.MT.20	G 1" DN 20	56,-	10
AZC.MT.25	G 1"1/4 DN 25	98,-	6



objednáací kód	provedení	cena v Kč	balení
AZC.SADA PROF		10.590,-	1

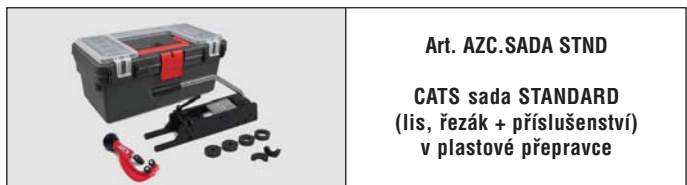

objednáací kód	provedení	cena v Kč	balení
AZC.SADA STND		6.490,-	1